

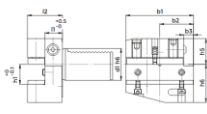





Promotion 2026

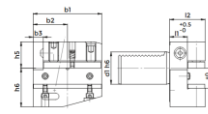

DIN69880 VDI B1 Katalog S. 516	
	
Artikelnummer	Preis €
B1-30x20x40	59 €
B1-40x25x44	70 €
B1-50x32x55	108 €

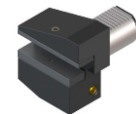
DIN69880 VDI B2 Katalog S. 517	
	
Artikelnummer	Preis €
B2-30x20x40	59 €
B2-40x25x44	70 €
B2-50x32x55	108 €

DIN69880 VDI B3 Katalog S. 518	
	
Artikelnummer	Preis €
B3-30x20x40	59 €
B3-40x25x44	70 €
B3-50x32x55	108 €

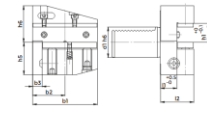
DIN69880 VDI B4 Katalog S. 519	
	
Artikelnummer	Preis €
B4-30x20x40	71 €
B4-40x25x44	76 €
B4-50x32x55	113 €

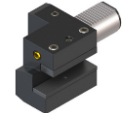
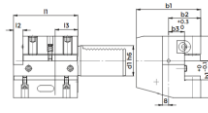
DIN69880 VDI C1 Katalog S. 522	
	
Artikelnummer	Preis €
C1-30x20x70	81 €
C1-40x25x85	101 €
C1-50x32x100	139 €

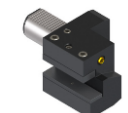
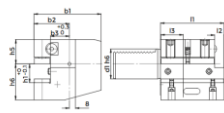
DIN69880 VDI C2 Katalog S. 523	
	
Artikelnummer	Preis €
C2-30x20x70	81 €
C2-40x25x85	101 €
C2-50x32x100	139 €

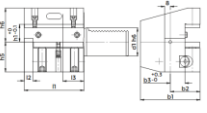
DIN69880 VDI C3 Katalog S. 524	
	
Artikelnummer	Preis €
C3-30x20x70	81 €
C3-40x25x85	101 €
C3-50x32x100	139 €

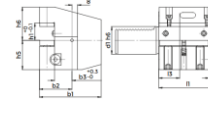
DIN69880 VDI C4 Katalog S. 525	
	
Artikelnummer	Preis €
C4-30x20x70	88 €
C4-40x25x85	106 €
C4-50x32x100	176 €

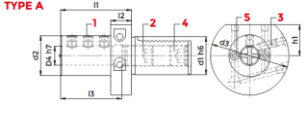
DIN69880 VDI E2 Katalog S. 528	
	
Artikelnummer	Preis €
E2-30x06	62 €
E2-30x08	62 €
E2-30x10	62 €
E2-30x12	62 €
E2-30x16	62 €
E2-30x20	62 €
E2-30x25	62 €
E2-30x32	62 €
E2-30x40	62 €
E2-40x06	66 €
E2-40x08	66 €
E2-40x10	66 €
E2-40x12	66 €
E2-40x16	66 €
E2-40x20	66 €
E2-40x25	66 €
E2-40x32	66 €
E2-40x40	66 €
E2-40x50	87 €
E2-50x12	93 €
E2-50x16	93 €
E2-50x20	93 €
E2-50x25	93 €
E2-50x32	93 €
E2-50x40	93 €
E2-50x50	93 €

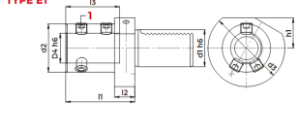
DIN69880 VDI E1 Katalog S. 527	
	
Artikelnummer	Preis €
E1-30x16	60 €
E1-30x20	60 €
E1-30x25	60 €
E1-30x32	60 €
E1-30x40	64 €
E1-40x16	64 €
E1-40x20	64 €
E1-40x25	64 €
E1-40x32	64 €
E1-40x40	64 €
E1-40x50	83 €
E1-50x20	93 €
E1-50x25	93 €
E1-50x32	93 €
E1-50x40	93 €
E1-50x50	93 €

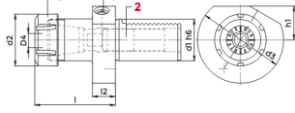
DIN69880 VDI E4 Katalog S. 531	
	
Artikelnummer	Preis €
E4-30x25	68 €
E4-30x32	68 €
E4-30x40	71 €
E4-40x25	73 €
E4-40x32	73 €
E4-40x40	74 €

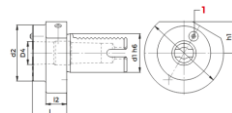
DIN69880 VDI F Katalog S. 534	
	
Artikelnummer	Preis €
F30-MKD1	77 €
F30-MKD2	77 €
F30-MKD3	77 €
F40-MKD1	83 €
F40-MKD2	83 €
F40-MKD3	83 €

DIN69880 VDI HK1 Katalog S. 537



Artikelnummer	Preis €
H130K	589 €
H140K	642 €

Montageunterstützung Katalog S. 679



Artikelnummer	Preis €
237-32490 (VDI30)	260 €
237-32590 (VDI40)	260 €

fester Kegelaustreiber Katalog S. 679



Artikelnummer	Preis €
237-32320 SK40	227 €
237-32330 BT40	227 €

ER Spannzangen Katalog S. 631



Artikelnummer	Preis €
ER8 Ø01-05	7 €
ER11 Ø01-07	7 €
ER16 Ø01-10	6 €
ER20 Ø02-12	6 €
ER25 Ø01-16	6 €
ER32 Ø02-20	6 €
ER40 Ø03-30	10 €

ER Spannzangensets Katalog S. 632



Artikelnummer	Preis €
SERIE-ER8 Ø1-5	59 €
SERIE-ER11 Ø1-7	70 €
SERIE-ER16 Ø1-10	52 €
SERIE-ER20 Ø2-13	59 €
SERIE-ER25 Ø2-16	77 €
SERIE-ER32 Ø3-20	96 €

ERW Spannzangen Katalog S. 631



Artikelnummer	Preis €
ER11 Ø7,5-08	17 €
ER16 Ø10,5-12	18 €
ER20 Ø12,5-15	18 €
ER25 Ø16,5-20	18 €
ER32 Ø20,5-25	11 €
ER40 Ø30,5-32	21 €

ER Spannzangen HP Katalog S. 631



Artikelnummer	Preis €
ER16HP Ø1-10	9 €
ER25HP Ø1-16	12 €
ER32HP Ø2-20	12 €
ER40HP Ø3-30	15 €

DIN 6343 173E Katalog S. 679



Artikelnummer	Preis €
0709 Ø6-42	38 €

DIN 6343 185E Katalog S. 679



Artikelnummer	Preis €
0759 Ø10-60	67 €

Nullpunktmesser Katalog S. 684



Artikelnummer	Preis €
0351 ZOP50	94 €

Nullpunktmesser mit Magnetfuß Katalog S. 684



Artikelnummer	Preis €
0354 ZDI100	139 €

Nullpunktmesser mit Messuhr Katalog S. 684



Artikelnummer	Preis €
0349 ZDI50	118 €

Messtaster mit Messuhr Katalog S. 689





Artikelnummer	Preis €
0584 CTA20-04	398 €
0585 CTA20-08	419 €

Schlüssel für ER-Standardspannmuttern



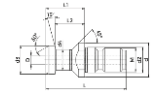

Artikelnummer	Preis €
816-203000 ER16	7 €
816-203001 ER25	7 €
816-203002 ER32	7 €
816-203003 ER40	9 €

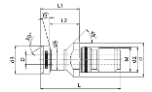
DIN69872 Anzugsbolzen		Katalog S. 657
		
Artikelnummer	Bezeichnung	Preis €
217-21201	ISO 40 - mit Bohrung	5 €
217-21202	ISO 50 - mit Bohrung	10 €

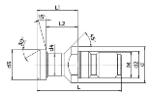
DIN69872 Anzugsbolzen + Dichtungsring		Katalog S. 657
		
Artikelnummer	Bezeichnung	Preis €
217-21305	ISO 40 - mit Bohrung	6 €
217-21306	ISO 50 - mit Bohrung	10 €

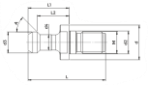
DIN69872 Anzugsbolzen + Dichtungsring		Katalog S. 657
		
Artikelnummer	Bezeichnung	Preis €
217-21301	ISO 40 - ohne Bohrung	6 €
217-21302	ISO 50 - ohne Bohrung	10 €

MAS/BT Anzugsbolzen		Katalog S. 661
		
Artikelnummer	Bezeichnung	Preis €
217-21501	BT 40 - 45° - ohne Bohrung	7 €
217-21502	BT 40 - 60° - ohne Bohrung	7 €
217-21503	BT 40 - 90° - ohne Bohrung	7 €

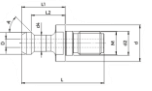
MAS/BT Anzugsbolzen		Katalog S. 661
		
Artikelnummer	Bezeichnung	Preis €
217-22207	BT 40 - 45° - mit Bohrung	7 €
217-22206	BT 40 - 60° - mit Bohrung	7 €
217-22208	BT 40 - 90° - mit Bohrung	7 €

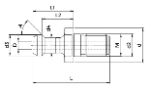
DIN69871 Anzugsbolzen SK		Katalog S. 662
		
Artikelnummer	Bezeichnung	Preis €
217-22213	SK 40 - 45° - mit Bohrung	8 €

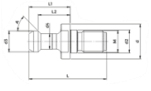
MAS/BT Anzugsbolzen + Dichtungsring		Katalog S. 661
		
Artikelnummer	Bezeichnung	Preis €
217-21402	BT 40 - 45° - ohne Bohrung	7 €
217-21401	BT 40 - 60° - ohne Bohrung	7 €
217-21403	BT 40 - 90° - ohne Bohrung	7 €

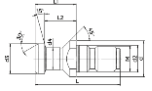
DIN69872 Anzugsbolzen		Katalog S. 657
		
Artikelnummer	Bezeichnung	Preis €
217-21207	ISO 40 - ohne Bohrung	5 €
217-21208	ISO 50 - ohne Bohrung	10 €

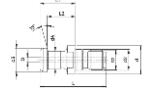
JIS B 6339 Anzugsbolzen 6339		Katalog S. 663
		
Artikelnummer	Bezeichnung	Preis €
217-22134	6339 ISO 40 - mit Bohrung	8 €

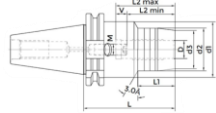
DIN69871 Hydrodehnspannfutter SK40		Katalog S. 197
		
Artikelnummer	Bezeichnung	Preis €
252-11305	TC40-HC6-80,5	209 €
252-11307	TC40-HC8-80,5	209 €
252-11309	TC40-HC10-80,5	206 €
252-11311	TC40-HC12-80,5	206 €
252-11327	TC40-HC14-80,5	206 €
252-11313	TC40-HC16-80,5	206 €
252-11328	TC40-HC18-80,5	206 €
252-11325	TC40-G20CS-64,5	165 €
252-11315	TC40-HC20-80,5	206 €
252-11317	TC40-HC25-80,5	206 €
252-11318	TC40-HC32-80,5	206 €

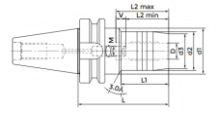
Hydrodehnspannfutter BT40		Katalog S. 196
		
Artikelnummer	Bezeichnung	Preis €
252-11422	BT40-HC6-90	209 €
252-11423	BT40-HC8-90	209 €
252-11424	BT40-HC10-90	206 €
252-11425	BT40-HC12-90	206 €
252-11426	BT40-HC14-90	206 €
252-11427	BT40-HC16-90	206 €
252-11428	BT40-HC18-90	206 €
252-11443	BT40-G20CS-72,5	171 €
252-11429	BT40-HC20-90	206 €
252-11483	BT40-HC25-100	206 €
252-11485	BT40-HC32-105	206 €

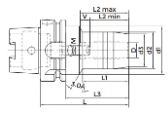
DIN69893A Hydrodehnspannfutter HSK63		Katalog S. 198
		
Artikelnummer	Bezeichnung	Preis €
252-11737	HSK63A-HC6-70	272 €
252-11738	HSK63A-HC8-70	272 €
252-11739	HSK63A-HC10-80	246 €
252-11740	HSK63A-HC12-85	246 €
252-11741	HSK63A-HC14-85	246 €
252-11742	HSK63A-HC16-90	246 €
252-11744	HSK63A-HC20-90	246 €
252-11746	HSK63A-HC32-125	246 €

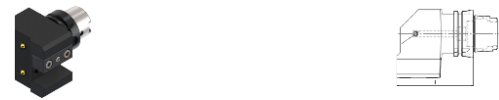
DIN69893T Axialer Werkzeughalter HSK-T Katalog S. 270

Artikelnummer	Bezeichnung	Preis €
142-11402	H63TAD25R	330 €

DIN69893T 45° Werkzeughalter HSK-T Katalog S. 273

Artikelnummer	Bezeichnung	Preis €
141-11405	H63TA25L	341 €

DIN69893T Axialer Bohrstangenhalter HSK-T Katalog S. 274

Artikelnummer	Bezeichnung	Preis €
145-21402	H63TAX-E2x08	146 €
145-21403	H63TAX-E2x10	146 €
145-21404	H63TAX-E2x12	146 €
145-21406	H63TAX-E2x16	146 €
145-21408	H63TAX-E2x20	146 €
145-21409	H63TAX-E2x25	146 €
145-21410	H63TAX-E2x32	146 €
145-21411	H63TAX-E2x40	146 €

DIN69893 ER-Spannzangenfutter HSK M Katalog S. 48

Artikelnummer	Bezeichnung	Preis €
214-31707	HSK63AH100ER25	74 €
214-31708	HSK63AH100ER32	74 €
214-31709	HSK63AH120ER40	78 €
214-31720	HSK63AH160ER32	103 €
214-31721	HSK63AH160ER40	106 €

DIN69893 ER-Spannzangenfutter HSK63 Katalog S. 46

Artikelnummer	Bezeichnung	Preis €
214-31724	HSK63AH90ER16M	74 €
214-31736	HSK63AH160ER16M	103 €
214-31737	HSK63AH160ER25M	103 €

DIN69893 kombinierte Fräsdornhalter HSK63 Katalog S. 41

Artikelnummer	Bezeichnung	Preis €
216-11708	HSK63AH60D16C	117 €
216-11709	HSK63AH60D22C	109 €
216-11710	HSK63AH60D27C	109 €
216-11711	HSK63AH65D32C	111 €
216-11712	HSK63AH70D40C	119 €
216-11728	HSK63AH100D22C	113 €
216-11736	HSK63AH100D27C	113 €
216-11777	HSK63AH100D16C	113 €
216-11778	HSK63AH100D32C	118 €
216-11779	HSK63AH100D40C	123 €

DIN69893 Bohrfutter mit Morsekegel HSK63 Katalog S. 43

Artikelnummer	Bezeichnung	Preis €
212-41706	HSK63AH100CM1P	99 €
212-41707	HSK63AH115CM2P	99 €
212-41708	HSK63AH135CM3P	102 €
212-41709	HSK63AH160CM4P	111 €

DIN69893 Bohrfutter mit Morsekegel HSK63 Katalog S. 34

Artikelnummer	Bezeichnung	Preis €
213-11715	HSK63AH65WE06	78 €
213-11716	HSK63AH65WE08	76 €
213-11717	HSK63AH65WE10	76 €
213-11718	HSK63AH80WE12	76 €
213-11719	HSK63AH80WE14	76 €
213-11720	HSK63AH80WE16	76 €
213-11721	HSK63AH80WE18	76 €
213-11722	HSK63AH80WE20	76 €
213-11723	HSK63AH110WE25	92 €
213-11724	HSK63AH110WE32	97 €

DIN69893 starre Fräsdornhalter HSK63 Katalog S. 39

Artikelnummer	Bezeichnung	Preis €
216-71708	HSK63AH45D16F-L	90 €
216-71709	HSK63AH50D22F-L	90 €
216-71710	HSK63AH55D27F-L	90 €
216-71711	HSK63AH60D32F-L	90 €
216-71791	HSK63AH100D16F-L	105 €
216-71792	HSK63AH100D22F-L	105 €
216-71793	HSK63AH100D27F-L	105 €
216-71794	HSK63AH100D32F-L	105 €

DIN69893 Gewindeschneidfutter HSK63 Katalog S. 55



Artikelnummer	Bezeichnung	Preis €
M801063	HSK63AH72GR1	260 €
M802063	HSK63AH110GR2	303 €

DIN69871 Gewindeschneidfutter SK40 Katalog S. 109

Artikelnummer	Bezeichnung	Preis €
M3010	TC 40 - B. 1	113 €
M3110	TC 40 - B. 2	147 €

BT/MAS Gewindeschneidfutter Katalog S. 144

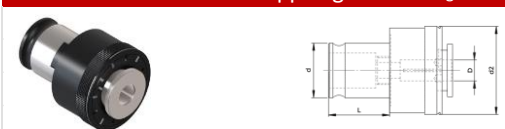

Artikelnummer	Bezeichnung	Preis €
M3310	BT 40 - B. 1	120 €
M3410	BT 40 - B. 2	155 €

Gewindebohrhülsen mit Kupplung Katalog S. 673

Artikelnummer		Preis €
IBS1-3.5X2.7	M3	35 €
IBS1-4.5X3.4	M4	35 €
IBS1-5.5X4.3		35 €
IBS1-6X4.9	M5-M6	35 €
IBS1-7X5.5		35 €
IBS1-8X6.2	M8	35 €
IBS1-9X7	M12	35 €
IBS1-10X8	M10	35 €
IBS1-11X9	M14	35 €
IBS2-6X4.9	M5-M6	46 €
IBS2-7X5.5		46 €
IBS2-8X6.2	M8	46 €
IBS2-9X7	M12	46 €
IBS2-10X8	M10	46 €
IBS2-11X9	M14	46 €
IBS2-12X9		46 €
IBS2-14X11		46 €
IBS2-16X12		46 €
IBS2-18X14.5		46 €

Gewindebohrhülsen ohne Kupplung Katalog S. 672

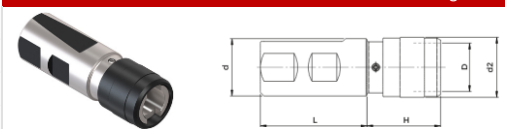
Artikelnummer		Preis €
IBC1-3.5X2.7	M3	14 €
IBC1-4.5X3.4	M4	14 €
IBC1-4X3.15	M3,5	14 €
IBC1-5,5X4.3		14 €
IBC1-6X4.9	M5-M6	14 €
IBC1-7X5.5		14 €
IBC1-8X6.2	M8	14 €
IBC1-9X7	M12	14 €
IBC1-10X8	M10	14 €
IBC1-11X9	M14	14 €
IBC2-6x4,9	M5-M6	20 €
IBC2-7x5,5		20 €
IBC2-8X6.2	M8	20 €
IBC2-9X7	M12	20 €
IBC2-10X8	M10	20 €
IBC2-11X9	M14	20 €
IBC2-12X9		20 €
IBC2-14X11		20 €
IBC2-16X12		20 €
IBC2-18X14.5		20 €

Gewindeschneidfutter Weldon Katalog S. 595

Artikelnummer		Preis €
M401020	WE 20 - B. 1	127 €
M401025	WE 25 - B. 1	127 €
M401032	WE 32 - B. 1	129 €
M401040	WE 40 - B. 1	174 €
3179	WE 20 - B. 2	159 €
M402025	WE 25 - B. 2	157 €
M402032	WE 32 - B. 2	162 €
M402040	WE 40 - B. 2	166 €

DIN69871 ER Spannzangenfutter Katalog S. 95



Artikelnummer	Bezeichnung	Preis €
214-91333	TC 40 - ER 11 GM / H 70 SLIM LINE	71 €
214-91334	TC 40 - ER 11 GM / H100 SLIM LINE	83 €
214-91335	TC 40 - ER 11 GM / H160 SLIM LINE	109 €
214-91336	TC 40 - ER 16 GM / H 70 SLIM LINE	67 €
214-91337	TC 40 - ER 16 GM / H100 SLIM LINE	76 €
214-91338	TC 40 - ER 16 GM / H160 SLIM LINE	109 €
214-91348	TC 40 - ER 20 GM / H 70 SLIM LINE	67 €
214-91349	TC 40 - ER 20 GM / H100 SLIM LINE	76 €
214-91350	TC 40 - ER 20 GM / H160 SLIM LINE	109 €
214-91339	TC 40 - ER 25 GM / H 70 SLIM LINE	67 €
214-91340	TC 40 - ER 25 GM / H100 SLIM LINE	76 €
214-91341	TC 40 - ER 25 GM / H160 SLIM LINE	109 €

BT/MAS ER Spannzangenfutter Katalog S. 133



Artikelnummer	Bezeichnung	Preis €
214-91448	BT 30 - ER 11 GM / H 70 SLIM LINE	59 €
214-91433	BT 40 - ER 11 GM / H 70 SLIM LINE	71 €
214-91434	BT 40 - ER 11 GM / H 100 SLIM LINE	83 €
214-91435	BT 40 - ER 11 GM / H 160 SLIM LINE	109 €
214-91436	BT 40 - ER 16 GM / H 70 SLIM LINE	55 €
214-91437	BT 40 - ER 16 GM / H 100 SLIM LINE	76 €
214-91438	BT 40 - ER 16 GM / H 160 SLIM LINE	109 €
214-91450	BT 40 - ER 20 GM / H 70 SLIM LINE	67 €
214-91451	BT 40 - ER 20 GM / H 100 SLIM LINE	76 €
214-91452	BT 40 - ER 20 GM / H 160 SLIM LINE	109 €
214-91439	BT 40 - ER 25 GM / H 70 SLIM LINE	67 €
214-91440	BT 40 - ER 25 GM / H 100 SLIM LINE	76 €
214-91441	BT 40 - ER 25 GM / H 160 SLIM LINE	109 €

DIN69871 Fräsdornhalter mit Morsekegel Gait Katalog S. 90



Artikelnummer	Bezeichnung	Preis €
212-21201	TC 40- CM 1 FRESE	62 €
212-21202	TC 40- CM 2 FRESE	62 €
212-21203	TC 40- CM 3 FRESE	62 €
212-21204	TC 40- CM 4 FRESE	67 €

BT/MAS Fräsdornhalter mit Morsekegel Katalog S. 128



Artikelnummer	Bezeichnung	Preis €
212-21502	BT 40 - CM 2 FRESE	62 €
212-21503	BT 40 - CM 3 FRESE	62 €
212-21504	TC 40 - CM 3 FRESE	67 €

DIN69871 Bohrfutter mit Morsekegel Katalog S. 90



Artikelnummer	Bezeichnung	Preis €
212-41201	TC 40 - CM 1 PUNTE	41 €
212-41202	TC 40 - CM 2 PUNTE	41 €
212-41203	TC 40 - CM 3 PUNTE	41 €
212-41204	TC 40 - CM 4 PUNTE	46 €

BT/MAS Bohrfutter mit Morsekegel Katalog S. 128



Artikelnummer	Bezeichnung	Preis €
212-41501	BT 40 - CM 1 PUNTE	41 €
212-41502	BT 40 - CM 2 PUNTE	41 €
212-41503	BT 40 - CM 3 PUNTE	41 €
212-41504	BT 40 - CM 4 PUNTE	46 €

DIN69871 Fräsfutter mit Weldon Katalog S. 78



Artikelnummer	Bezeichnung	Preis €
213-11326	TC 40 - WE 6 / H 50	41 €
213-11327	TC 40 - WE 8 / H 50	41 €
213-11328	TC 40 - WE 10 / H 50	41 €
213-11329	TC 40 - WE 12 / H 50	41 €
213-11330	TC 40 - WE 14 / H 50	41 €
213-11324	TC 40 - WE 16 / H 63	41 €
213-11331	TC 40 - WE 18 / H 63	41 €
213-11325	TC 40 - WE 20 / H 63	41 €
213-11323	TC 40 - WE 25 / H 100	46 €
213-11332	TC 40 - WE 32 / H 100	50 €

BT/MAS Fräsfutter mit Weldon Katalog S. 116



Artikelnummer	Bezeichnung	Preis €
213-11413	BT 40 - WE 6 / H 50	41 €
213-11414	BT 40 - WE 8 / H 50	41 €
213-11415	BT 40 - WE 10 / H 63	41 €
213-11416	BT 40 - WE 12 / H 63	41 €
213-11417	BT 40 - WE 14 / H 63	41 €
213-11418	BT 40 - WE 16 / H 63	41 €
213-11419	BT 40 - WE 18 / H 63	41 €
213-11420	BT 40 - WE 20 / H 63	41 €
213-11421	BT 40 - WE 25 / H 90	46 €
213-11422	BT 40 - WE 32 / H 100	50 €

DIN69871 Fräsfutter mit Fräsdornhalter Katalog S. 87



Artikelnummer	Bezeichnung	Preis €
216-11201	TC 40 - D.16 C / H 55	57 €
216-11202	TC 40 - D.22 C / H 55	57 €
216-11203	TC 40 - D.27 C / H 55	57 €
216-11204	TC 40 - D.32 C / H 60	60 €
216-11205	TC 40 - D.40 C / H 60	67 €

MAS403/BT Fräsfutter mit Fräsdornhalter Katalog S. 87



Artikelnummer	Bezeichnung	Preis €
216-11501	BT 40 - D.16 C / H 55	57 €
216-11502	BT 40 - D.22 C / H 55	57 €
216-11503	BT 40 - D.27 C / H 55	57 €
216-11504	BT 40 - D.32 C / H 60	60 €
216-11505	BT 40 - D.40 C / H 60	67 €

DIN69871 starrer Fräsdornhalter Katalog S. 85



Artikelnummer	Bezeichnung	Preis €
216-71204	TC 40 - D. 16 FISSO / H 45	52 €
216-71205	TC 40 - D. 22 FISSO / H 45	52 €
216-71206	TC 40 - D. 27 FISSO / H 50	53 €
216-71207	T C 40 - D. 32 FISSO / H 55	57 €
216-71208	TC 40 - D. 40 FISSO / H 55	67 €

BT/MAS starrer Fräsdornhalter Katalog S. 123



Artikelnummer	Bezeichnung	Preis €
216-71507	BT 40 - D. 16 FISSO / H 45	52 €
216-71508	BT 40 - D. 22 FISSO / H 45	52 €
216-71509	BT 40 - D. 27 FISSO / H 45	53 €
216-71510	BT 40 - D. 32 FISSO / H 50	57 €
216-71511	BT 40 - D. 40 FISSO / H 55	67 €

DIN69893 Schrumpfaufnahme HSK63

Katalog S. 185

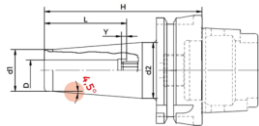

Artikelnummer	Bezeichnung	Preis €
251-21728	HSK63AH80K06-HTT	99 €
251-21729	HSK63AH80K08-HTT	99 €
251-21730	HSK63AH85K10-HTT	99 €
251-11710	HSK63AH90K12-HTT	99 €
251-11712	HSK63AH95K16-HTT	99 €
251-11714	HSK63AH100K20-HTT	99 €
251-11725	HSK63AH120K06-HTT	126 €
251-11726	HSK63AH120K08-HTT	126 €
251-11727	HSK63AH120K10-HTT	126 €
251-11728	HSK63AH120K12-HTT	126 €
251-11730	HSK63AH120K16-HTT	126 €
251-21784	HSK63AH120K20-HTT	126 €

DIN69871 Schrumpfaufnahme SK40

Katalog S. 179

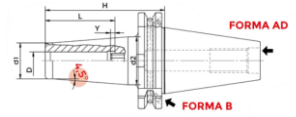

Artikelnummer	Bezeichnung	Preis €
251-11201	TC40H80K06-HTT	87 €
251-11202	TC40H80K08-HTT	87 €
251-11203	TC40H80K10-HTT	87 €
251-11204	TC40H80K12-HTT	87 €
251-11205	TC40H80K16-HTT	87 €
251-11208	TC40H80K20-HTT	87 €
251-11209	TC40H120K06-HTT	99 €
251-11210	TC40H120K08-HTT	99 €
251-11211	TC40H120K10-HTT	99 €
251-11212	TC40H120K12-HTT	99 €
251-11298	TC40H120K16-HTT	99 €

Schrumpfmachine



Artikelnummer	Bezeichnung	Preis €
KITDMPHSK100	MASCHINE+ZUBEHÖR+HSK100 ADAPTER	4.230 €
KITDMPHSK63	MASCHINE+ZUBEHÖR+HSK63 ADAPTER	4.230 €
KITDMPHSK50	MASCHINE+ZUBEHÖR+HSK50 ADAPTER	4.230 €
KITDMPTC/BT30	MASCHINE+ZUBEHÖR+TC/BT30 ADAPTER	4.230 €
KITDMPTC/BT40	MASCHINE+ZUBEHÖR+TC/BT40 ADAPTER	4.230 €
KITDMPTC/BT50	MASCHINE+ZUBEHÖR+TC/BT50 ADAPTER	4.230 €